

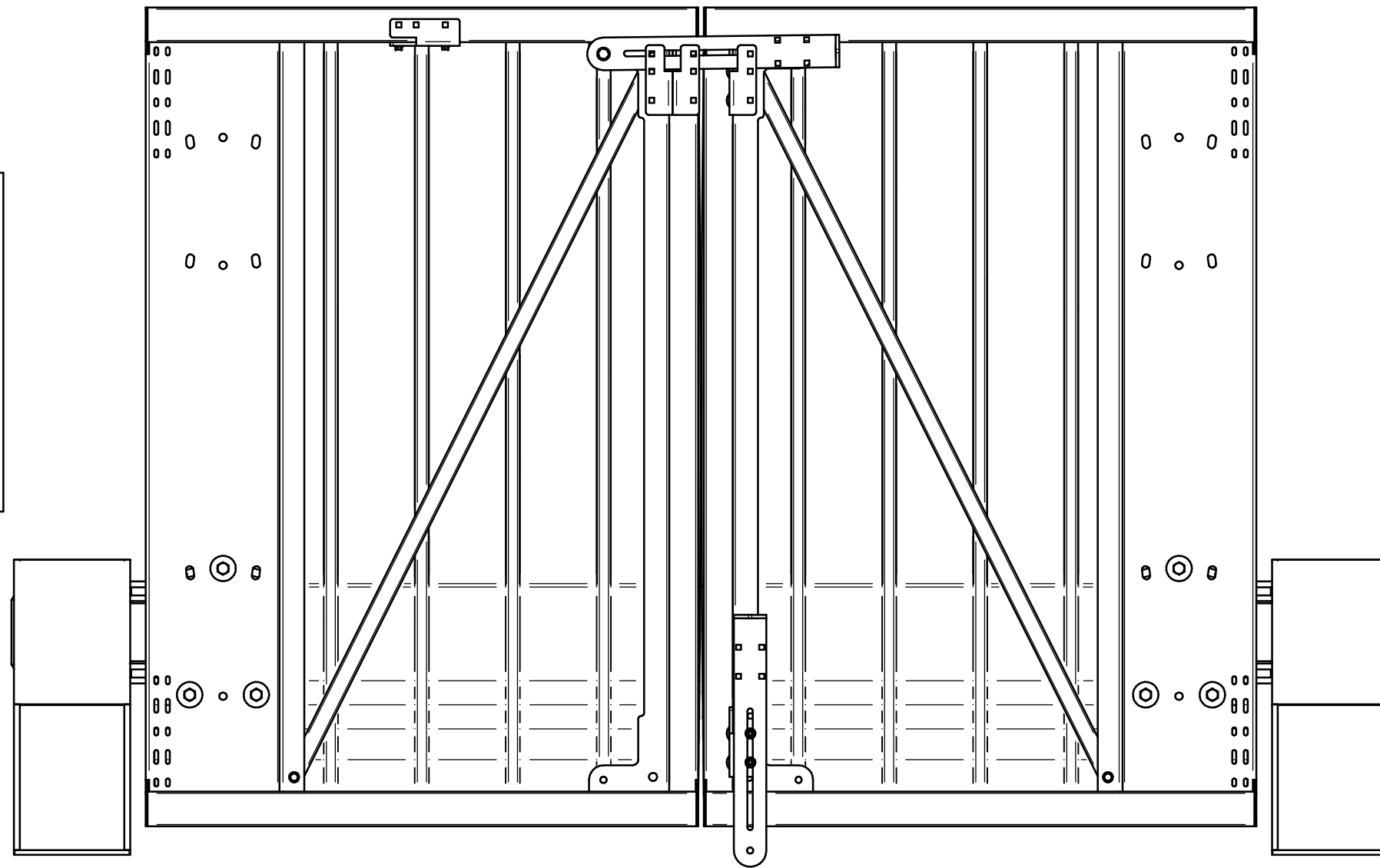



With every door a back plate is provided which you can weld on the I-Beam



 Q-LINE	Safety Wall door sizes Drawing nr: Safety wall doors	
	Material : Revision nr: rev nr	Date : 12-12-2019 Last Modified:12-12-2019
	A3	<small>This drawing is intellectual property off Q-Line b.v. and therefore it is not allowed to copy or multiply this drawing without the written approval of Q-Line b.v. All measurements are in mm, tolerances are according the NEN ISO 2768 FH</small>

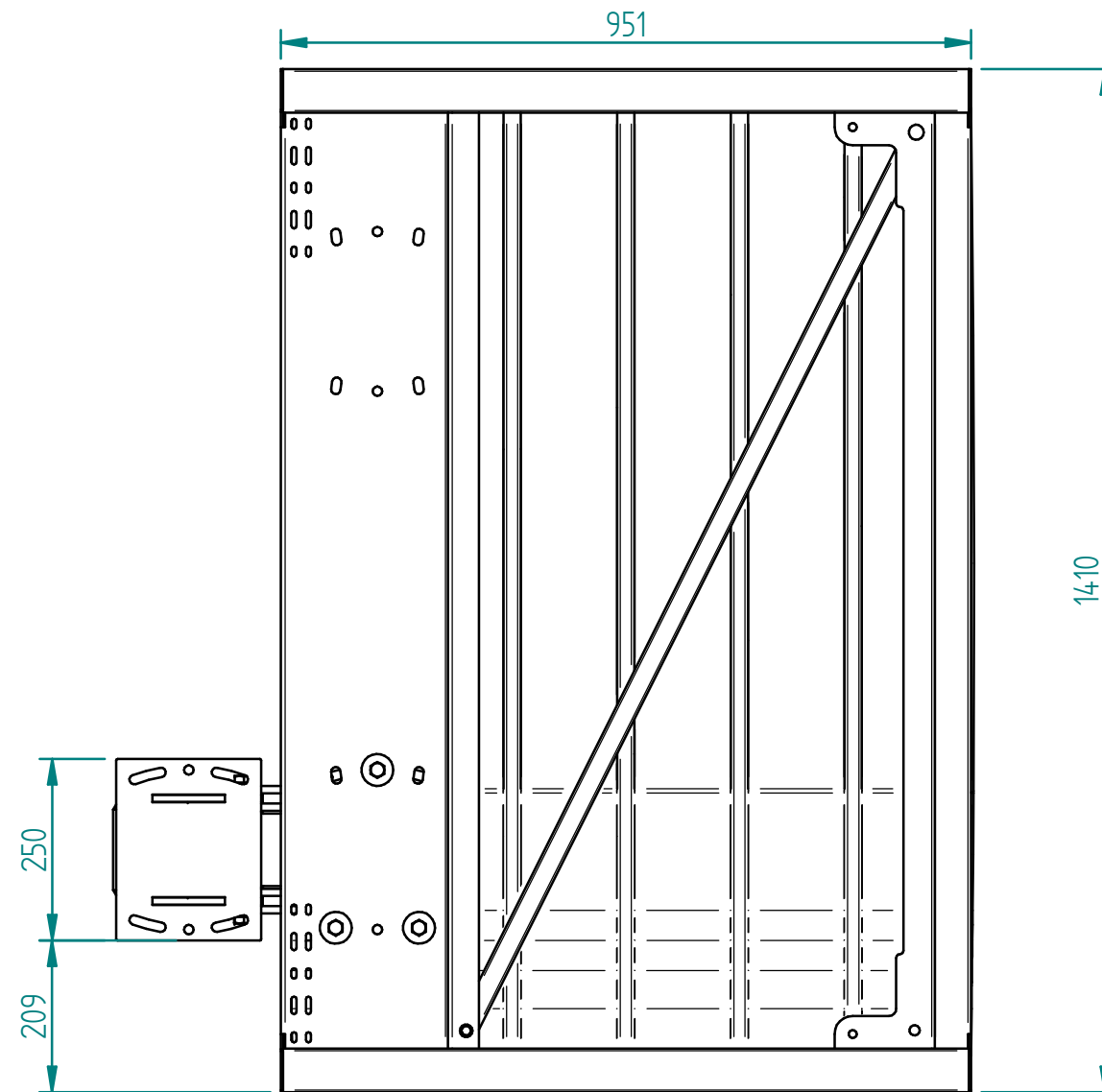
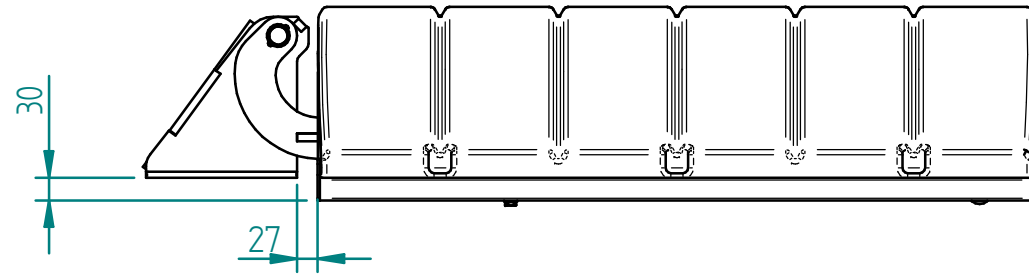
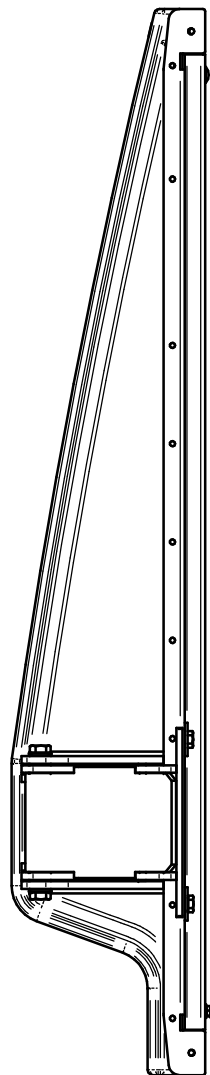

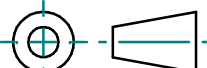
 Q-LINE	Safety Wall door sizes	
	Drawing nr: door 1 panel	
	Material :	Date : 12-12-2019
	Revision nr: rev nr	Last Modified: 12-12-2019
A3	<small>This drawing is intellectual property of Q-Line b.v. and therefore it is not allowed to copy or multiply this drawing without the written approval of Q-Line b.v. All measurements are in mm, tolerances are according to the NEN ISO 2768 FH</small>	

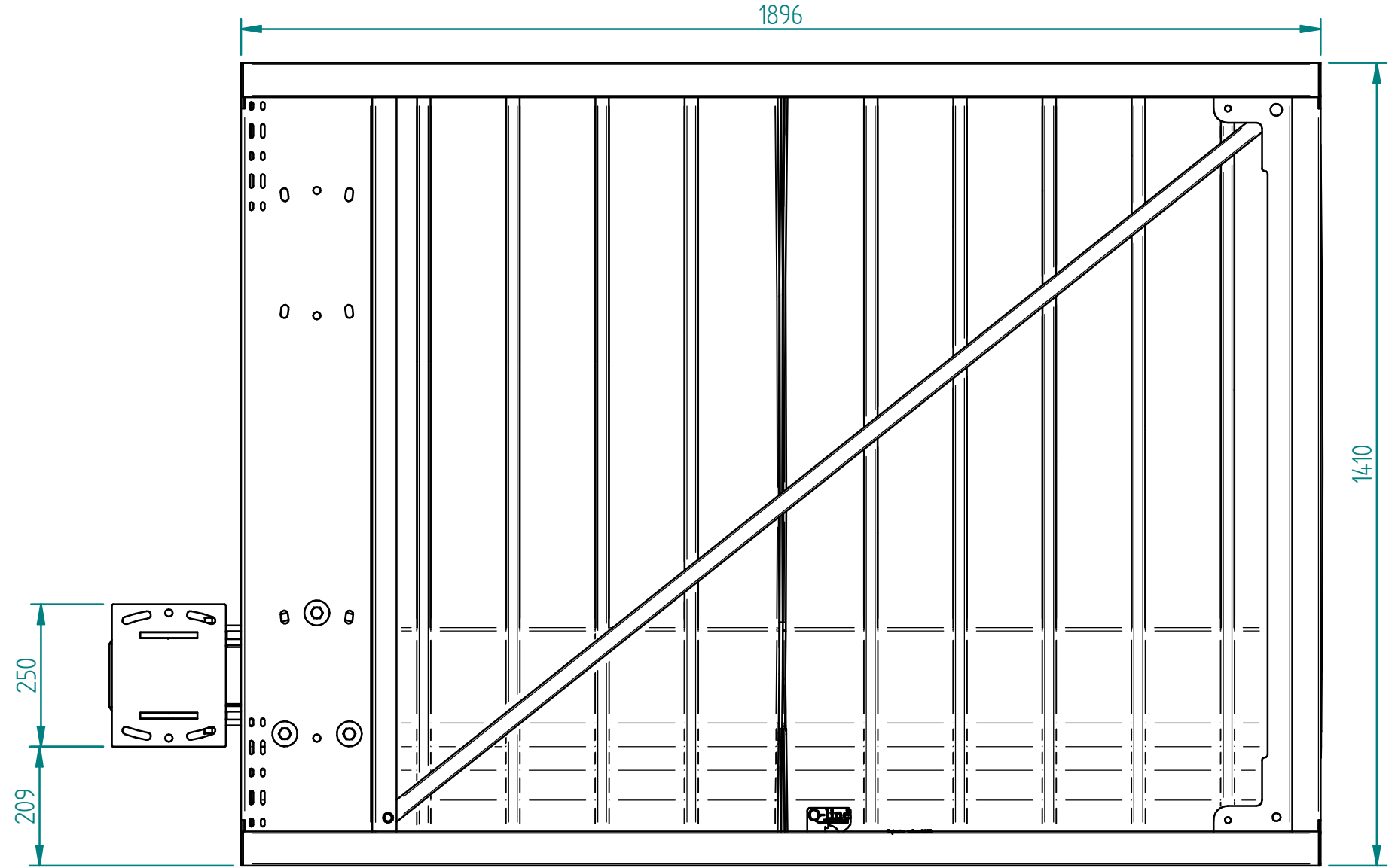
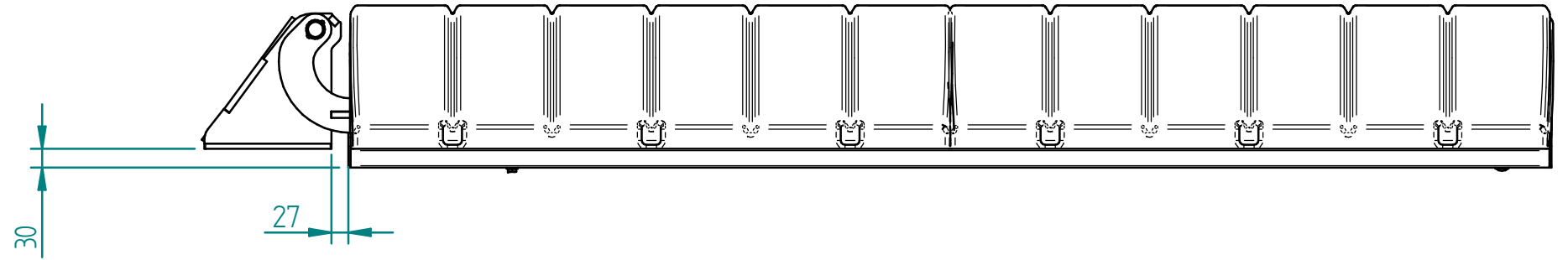
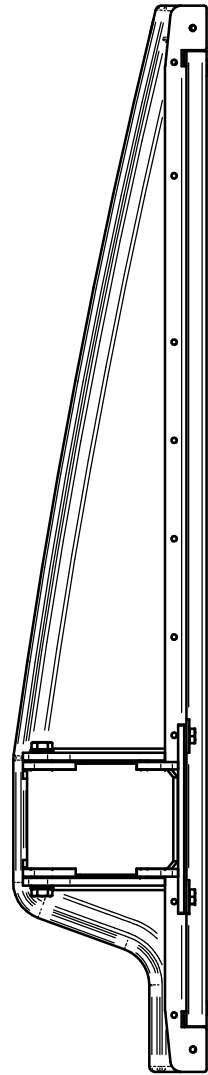

Safety Wall door sizes
Drawing nr: door 2 panels

	A3	Material :	Date : 12-12-2019
		Revision nr: rev nr	Last Modified:12-12-2019
<small>This drawing is intellectual property of Q-Line b.v. and therefore it is not allowed to copy or multiply this drawing without the written approval of Q-Line b.v. All measurements are in mm, tolerances are according to the NEN ISO 2768 FH</small>			

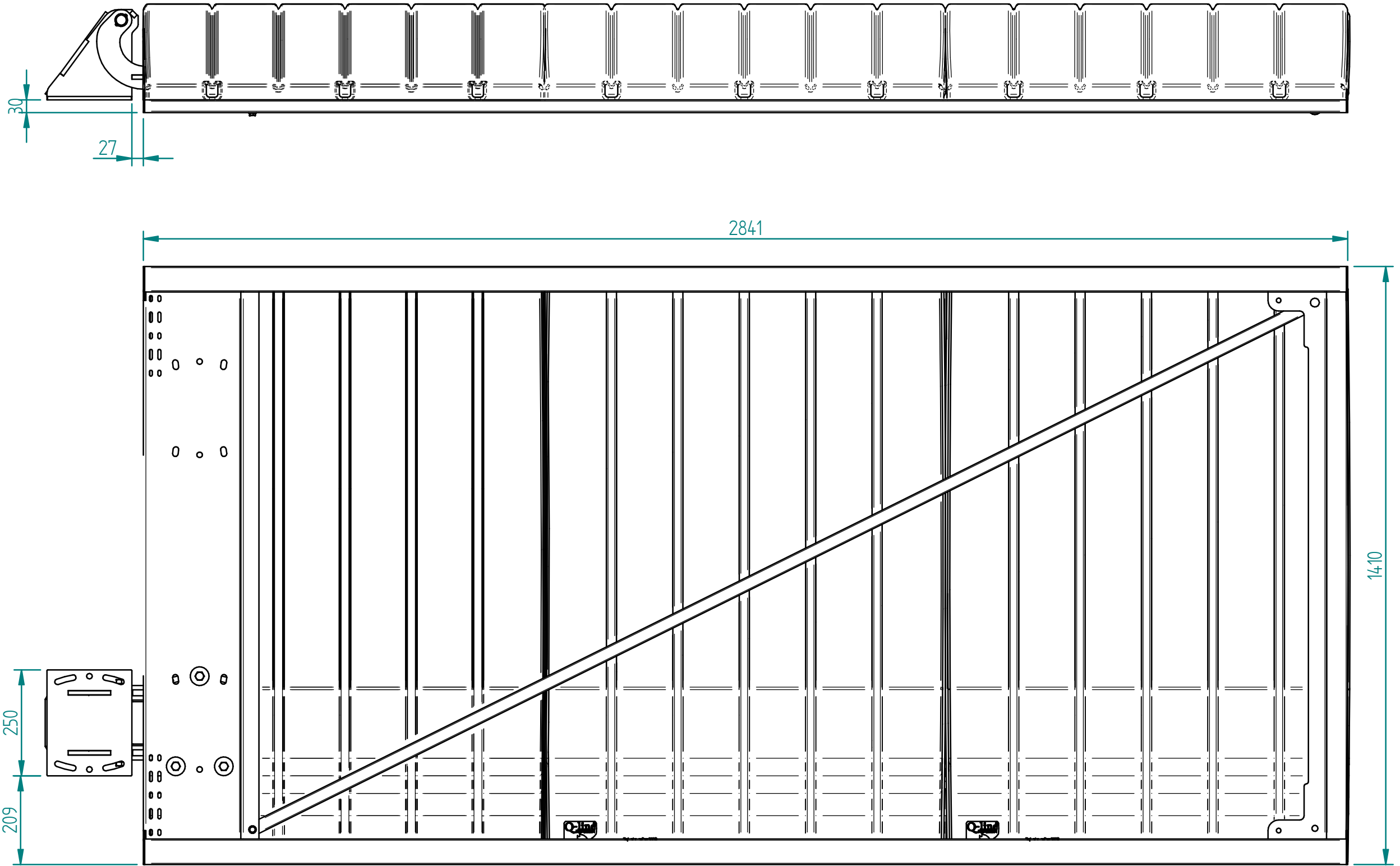
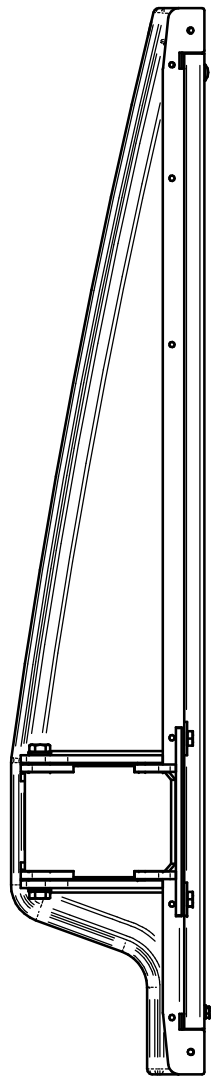

Safety Wall door sizes	
Drawing nr: door 3 panels	
Material :	Date : 12-12-2019
Revision nr: rev nr	Last Modified:12-12-2019
This drawing is intellectual property off Q-Line b.v. and therefore it is not allowed to copy or multiply this drawing without the written approval of Q-Line b.v. All measurements are in mm, tolerances are according the NEN ISO 2768 fH	

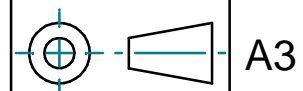

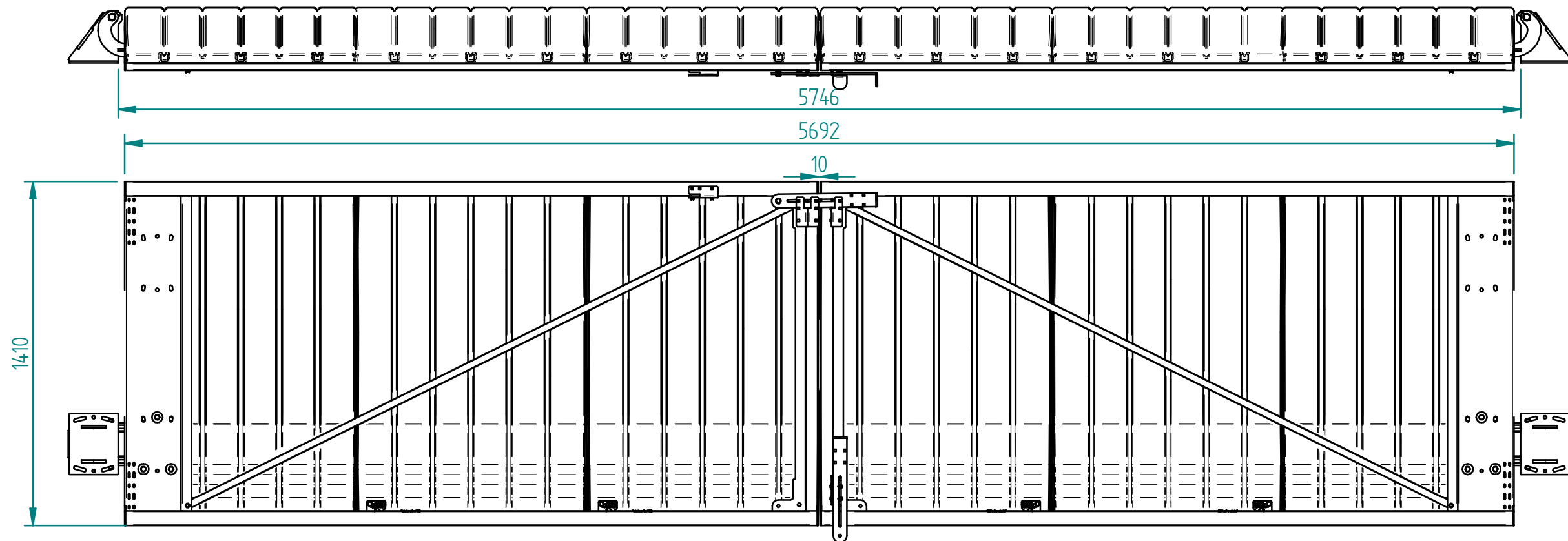
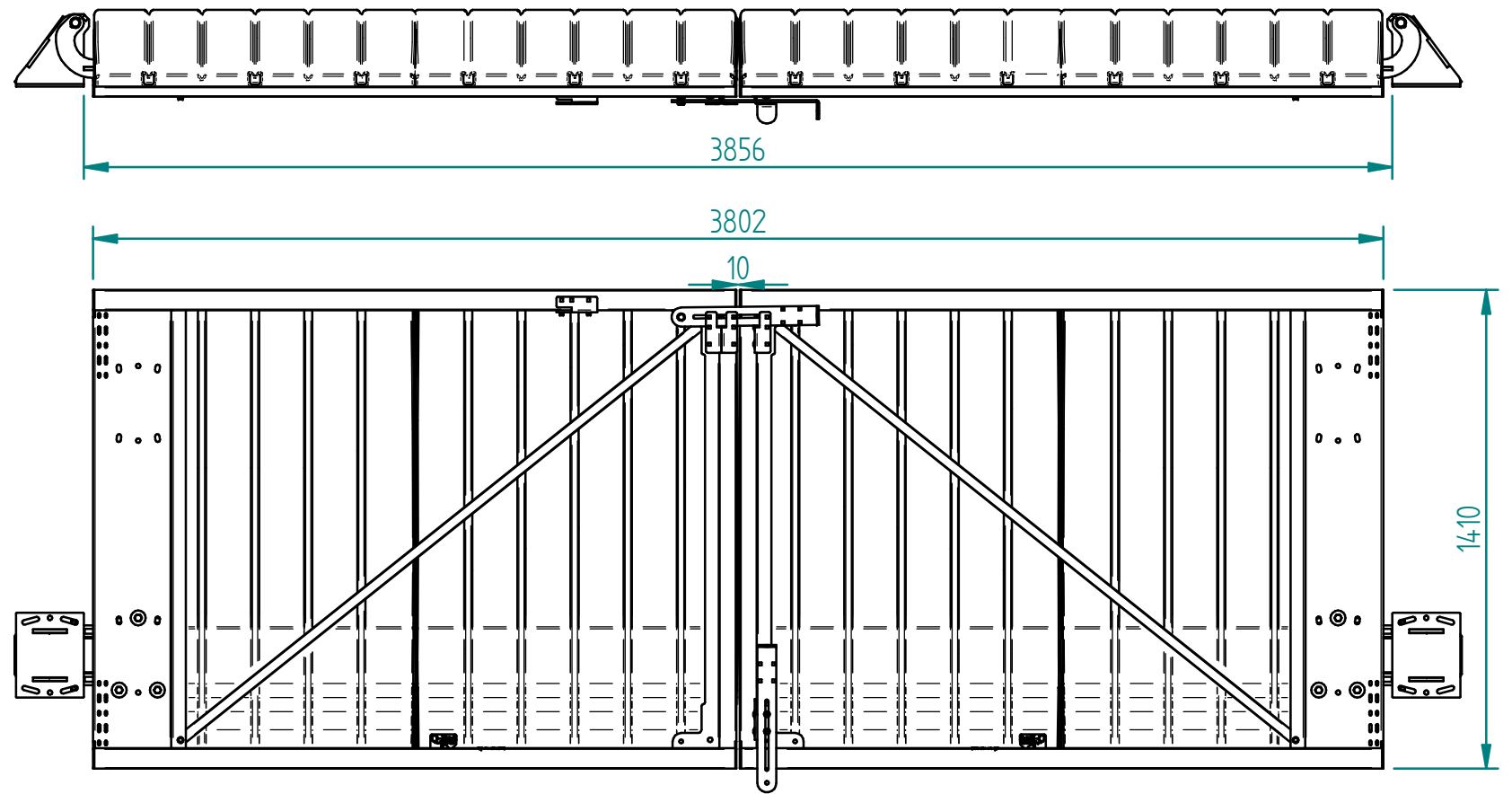
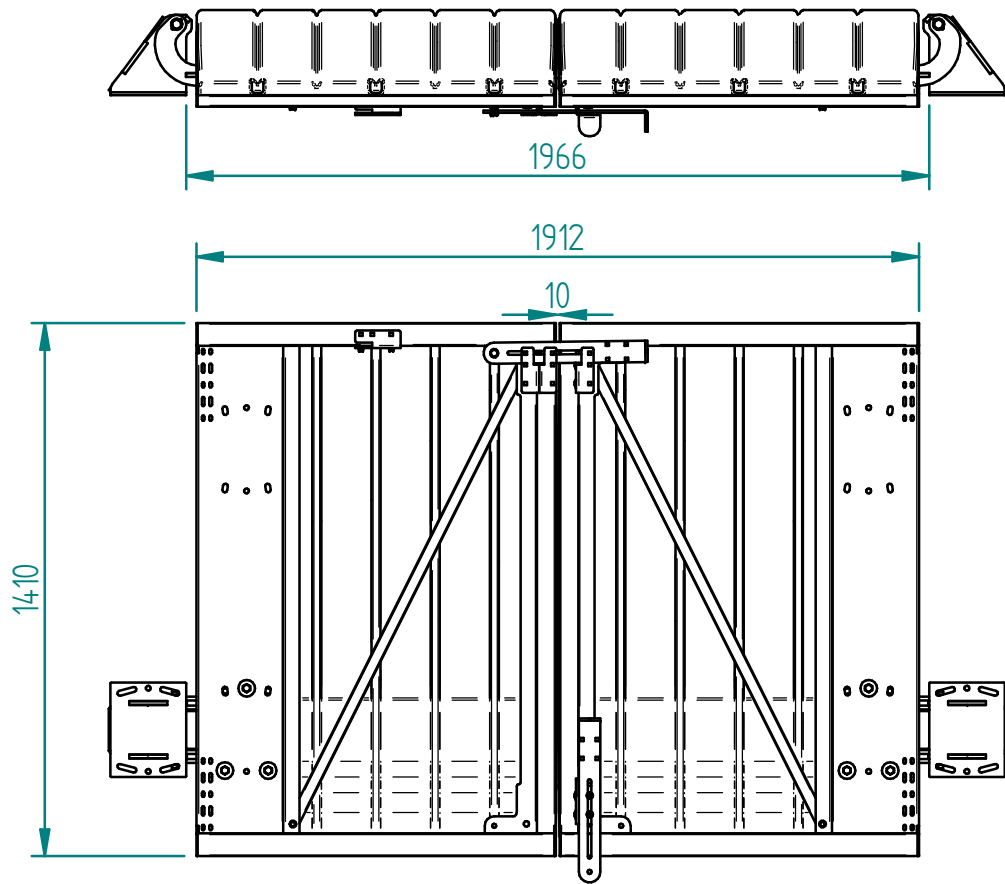

Safety Wall door sizes
Drawing nr: double gates

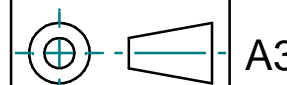

A3

Material :
Revision nr: rev nr

Date : 12-12-2019
Last Modified: 12-12-2019

This drawing is intellectual property of Q-Line b.v. and therefore it is not allowed to copy or multiply this drawing without the written approval of Q-Line b.v. All measurements are in mm, tolerances are according to the NEN ISO 2768 FH